

Genius 3020 User Manual



Contents

Change History	4
How to use this Manual	4
Introduction	5
Warranties and Liabilities	6
Safety Notices	7
Symbols	7
Safety Notice to Users	7
Declaration of Conformity	8
Environmental Declaration	9
Technical Specification	10
Environment	10
Generator Outlets	10
Electrical Requirements	10
General	10
Unpacking	11
Installation	12
Generator Environment	12
General Dimensions	12
Removal of Transit Brackets	13
Unit Controls	14
Rear Connections	14
Fittings Kit	15
Drain Connection	15
Electrical Connection	16
Selector Switches	17
Initial Purge Run	18
Connecting to the Application	20
Tubing Lengths	20
IMPORTANT DOCUMENTS	21
Normal Operation	22

On Demand Gas	22
Generator Cycling	22
Unusual Operation	22
Service Requirements	23
Service Schedule	23
Service Indication	23
Stage 2	24
Service Indication Reset	24
Service Plans	24
Cleaning	24
High Duty Indication	25
High Duty Indication Reset	25
Indication of Fault	25
Trouble Shooting	26

Change History

Rev.	Comment	Name	Date
1	Technical Specification Altered	Liam Couttie	03/06/2011
2	Filter Element Change	Liam Couttie	18/07/2011
3	Updated Service Hours	Liam Couttie	14/02/2012
4A	Capacitor Change	Liam Couttie	11/02/2014
4B	Technical Specification Correction	Liam Couttie	16/02/2015

How to use this Manual

This manual is intended for end users and has been written so that it can either be read as a step by step guide to installation and usage or as a reference document where you can skip to the relevant information.

Users of a hard copy version can refer to the contents page to find the relevant information. Users of the soft copy version can use the hyperlinks from the contents page as well as the hyperlinks between sections.

Please review each of the following sections carefully.

Thank you for selecting Peak Scientific to meet your Gas Generation needs, and should you require any further assistance or support please do not hesitate to contact Peak Scientific or Peak Partner from which you purchased your Generator.

Introduction

The Genius 3020 has been developed to cater for systems which require a Nitrogen gas supply.

This model combines two individual systems with separate Nitrogen outputs thus allowing two separate Mass Spectrometers to be run by the same Generator. Further features include:

- Quiet in operation – noise level of 54 db(A)
- Anti- vibration – maximum reduction of vibration
- Service indication – allowing you to plan your maintenance and keep your application uptime at a maximum
- Improved drainage – reduction of moisture carry over and thus increased reliability
- Re- heat technology – improves membrane performance and reliability
- Robust control system – improves safety and reliability of units

With the Genius 3020 based on proven technology, it selectively removes oxygen, moisture and other gases to leave clean, dry, phthalate free Nitrogen. Internal air compressors make this unit independent from in- house air supplies and fitted castors allow the user to easily position the unit in the lab.

To ensure this Generator model meets our high expectations with regards to reliability and performance, we have tested this new model extensively at our manufacturing plant and with end users around the world to ensure reliability and longevity of the system.



Warranties and Liabilities

1. The Company warrants that it has title to the Goods.
2. Subject to the provisions of this clause the Company warrants that the Goods shall comply in all material respects with any specification referred to in the Order Confirmation (as the same may be amended) and shall, subject thereto, be free from defects in material and workmanship for the lesser of a period of twelve months from the date of delivery or thirteen months from the date of dispatch from the factory.
3. Save as provided in this clause and except where the Goods are sold to a person dealing as a consumer (within the meaning of the Unfair Contract Terms Act 1977) all warranties, conditions or other terms implied by statute or common law are hereby expressly excluded save to the extent they may not be lawfully excluded. When the Goods are sold to a consumer within the meaning of the Unfair Contract Terms Act 1977 their statutory rights are not affected by the provisions of this clause.
4. In the event of the Customer making a claim in respect of any defect in terms of clause 2 hereof the Customer must.
 1. Reasonably satisfy the Company that the Goods have been properly installed, commissioned, stored, serviced and used and without prejudice to the generality of the foregoing that any defect is not the direct or indirect result of lack of repair and/or servicing, incorrect repair and/or servicing, use of wrong materials and/or incorrect spare parts
 2. Allow the company to inspect the Goods and/or any installation and any relevant packaging as and when reasonably required by the Company.
5. Subject to the Company being notified of any defect as is referred to in sub-clause 2 hereof within a reasonable time of it becoming apparent and subject always to the terms of sub-clause 4 hereof, the Company shall, in its option, replace or repair the defective Goods or refund a proportionate part of the Price. The Company shall have no further liability to the Customer (save as mentioned in sub-clause 6 hereof).
6. The Company shall be liable to indemnify the Customer in respect of any claim for death or personal injury to any person in so far as such is attributable to the negligence or breach of duty of the Company or any failure by the Company to comply with the provisions of sub-clause 2 hereof.
7. Save as provided in sub-clause 2 hereof the Company shall not be liable in respect of any claim by the Customer for costs, damages, loss or expenses (whether direct, indirect, consequential or otherwise) or indemnity in any respect howsoever arising including, but not by way of limitation, liability arising in negligence (other than pursuant to clause 6 above) that may be suffered by the Customer or any third party.

Safety Notices

Symbols

This manual uses the following symbols to highlight specific areas important to the safe and proper use of the Generator

	A WARNING notice denotes a hazard. It calls attention to an operating procedure, process or similar, which if not correctly performed or adhered to, could cause personal injury or in the worst case death. Do not proceed beyond a WARNING notice until the indicated conditions are fully understood or met.
	A CAUTION notice denotes a hazard. It calls attention to an operating procedure, process or similar, which if not correctly performed or adhered to, could cause damage to the Generator or the Application. Do not proceed beyond a CAUTION notice until the indicated conditions are fully understood or met.
	Caution, risk of electric shock. Ensure power to the Generator has been removed before proceeding.

Safety Notice to Users



These instructions must be read thoroughly and understood before installation and operation of your Peak Genius 3020 Generator. Use of the Generator in a manner not specified by Peak Scientific MAY impair the SAFETY provided by the equipment.



When handling, operating or carrying out any maintenance, personnel must employ safe engineering practices and observe all relevant local health and safety requirements and regulations. The attention of UK users is drawn to the Health and Safety at Work Act 1974, and the Institute of Electrical Engineers regulations.

Declaration of Conformity

We Peak Scientific Instruments Ltd.
Of Fountain Crescent, Inchinnan, Renfrewshire, PA4 9RE

Declare that:

Equipment: Nitrogen Gas Generator
Model: Genius 3020
Date: 03 / 05 / 2012

To which this declaration relates, is in conformity with the applicable EC directives, harmonized standards, and other normative requirements.

- **Low Voltage Directive 2006/95/EC**
EN 61010-1: 2010 Electrical Equipment for measurement, control and laboratory use.
CAN/CSA-C22.2 No.61010-1-04
Safety requirements for Electrical Equipment for Measurement, Control and Laboratory use, Part 1: General requirement.
- **Electromagnetic Compatibility Directive 2004/108/EC**
EN 61326-1: 2006 Electrical Equipment for measurement, control and laboratory use.
- **FCC 47 CFR Part 15 Class B**
Unintentional radiators; Conducted and Radiated emissions limits.
- **Machinery Directive - 2006/42/EC**

All evaluation, testing and certification issued by:

Nemko Canada Inc.
303 River Road
Ottawa, Ontario
Canada, K1V 1H2

Signed:  Name: Chris Pugh
Date: 3rd May 2012 Position: Engineering Director



Environmental Declaration

We Peak Scientific Instruments Ltd.
Of Fountain Crescent, Inchinnan, Renfrewshire, PA4 9RE

Declare that:

Equipment: Nitrogen Gas Generator
Model: Genius 3020

Is fully compliant with the following Directives

- 2002/96/EC WEEE (Waste of Electrical and Electronic Equipment)
- 2002/95/EC RoHS (Restriction of Hazardous Substance)

Peak Scientific Instruments Ltd fully complies with its obligations towards the European WEEE (Waste of Electrical and Electronic Equipment) Directive 2002/96/EC. These obligations are being met within the B2B compliance group.

Peak Scientific Instrument Ltd have developed all reasonable 'due dilligence' controls to ensure that our products comply with the principles and requirements of the European RoHS (Restriction of Hazardous Substances) Directive 2002/95/EC. Similar directives in the United States and China, for example, have also been captured within this program.

Where a specific certificate of compliance is required, this can be requested, on a product serial number basis, directly from Peak Scientific Instruments Ltd, by contacting us through our website on www.peakscientific.com

Signed:  Name: Chris Pugh
Date: 3rd May 2012 Position: Engineering Director



Technical Specification

Environment

Minimum operating ambient temperature	5°C (41°F)
Maximum operating ambient temperature	35°C (95°F)
Maximum relative humidity	80% Non-Condensing
Maximum altitude	2000 meters
Minimum storage temperature*	-20°C (-4°F)
Maximum storage temperature*	60°C (140°F)

*NOTE - When taken out of storage the Generator should be allowed to acclimatize at room temperature for a minimum of 3 hours before operation.

Generator Outlets

Maximum Flow (x2 systems)	32 L/min (1.13 cfm)
Maximum Pressure (x2 systems)	6.90 bar (100 psi)
Particles	<0.01µm
Phthalates	NONE
Suspended liquids	NONE
Gas outlets	2 x ¼" BSPP
Drain outlet	1 x ¼" BSPP
Pressure gauges	2

Electrical Requirements

Voltage	230 VAC ± 10%
Frequency	50/60 Hz
Current	12 Amps
Input connection	C20 Plug
Power cord (Supplied)	C19 socket to local connection (13A minimum)
Pollution degree	2
Installation category	II

General

Dimensions in cm (inches) W x D x H	60 x 85 x 133 (23.6 x 33.5 x 52.4)
Weight	189 kg (417 lb)
Shipping weight	265.5 kg (585 lb)
Noise level	54 dBA @1m

Unpacking

Although Peak Scientific takes every precaution with safe transit and packaging, it is advisable to fully inspect the unit for any sign of transit damage.

Check 'SHOCKWATCH' label for signs of rough handling prior to un-packing -



Any damage should be reported immediately to the carrier and Peak Scientific or the Peak Partner from where the unit was purchased.

Follow the unpacking instructions posted on the side of the crate. It will require two people to remove the unit from the shipping crate and to manoeuvre the Generator onto the floor.

Please save the product packaging for storage or future shipment of the Generator.

Note: Included with the Generator is a "Fittings Kit" containing mains power leads for UK, EU and US also all the required fittings. Be careful not to discard these with the packaging.

Installation

Generator Environment



The Generator is designed for indoor use only. It should be installed adjacent to the application(s) it is supplying. If this is not convenient then the unit can be sited elsewhere, however, consideration should be made of the lengths of pipe runs as pressure drops can result from extended runs of pipe. Please see the [Tubing lengths](#) section for further details.



Performance of the Generator (like all sophisticated equipment) is affected by ambient conditions. Note should also be taken to the proximity of Air Conditioning outlets. These can sometimes give rise to “pockets” of air with high relative humidity. Operation of the unit within such a pocket could adversely affect its performance. Consideration should also be given to the air flow around the unit. It is recommended that an air gap of 75mm (3”) should be maintained down both sides, at the rear and across the top of the unit. Please refer to the drawing below for the general dimensions of the unit.

Maximum Ambient Conditions: 35°C (dry bulb) 80%RH (Max) Non-Condensing

General Dimensions

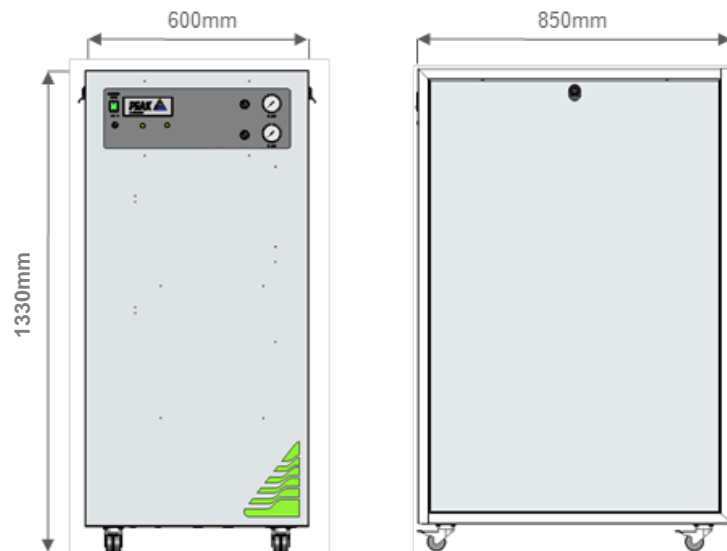

Figure 1 - General Dimensions



The Generator must always be placed on a level surface. Failure to do so will affect the performance of the Generator.

Removal of Transit Brackets



The transit brackets must be removed prior to switching the unit on. Failure to do so will result in damage to the equipment. This will void the warranty on the Generator and will result in a chargeable repair.

1. Using the 8mm hex key from the Fittings Kit, remove the side covers from the cabinet ensuring that earth cables are disconnected.
2. Remove the four screws with a #3 Pozidrive Screwdriver.
3. Slide the transit bracket out from under the compressor by pulling it towards you.
4. Repeat this for the compressor on the other side of the Generator.
5. Retain the transit brackets as these must be refitted if the Generator is to be transported again.

Note. Do not re-fit door panels in preparation for Voltage Check

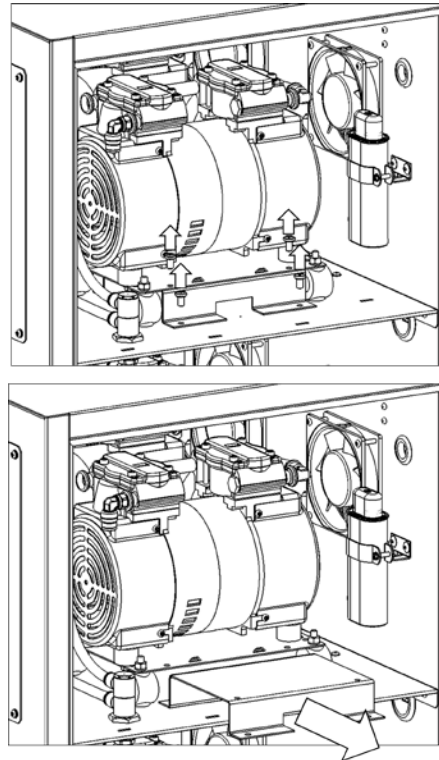

Figure 1: Transit Bracket Removal

Unit Controls

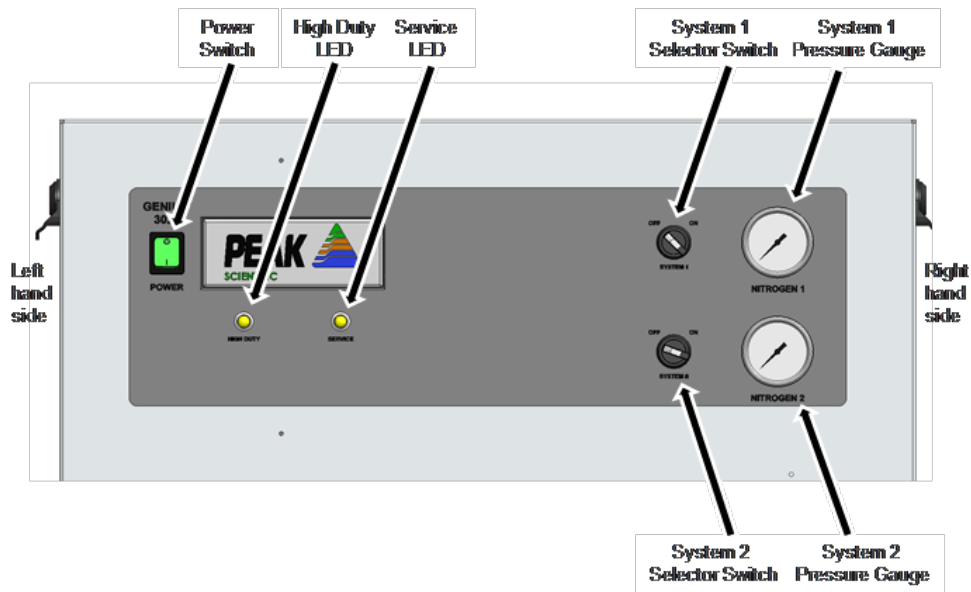

Figure 2: Unit controls

Rear Connections

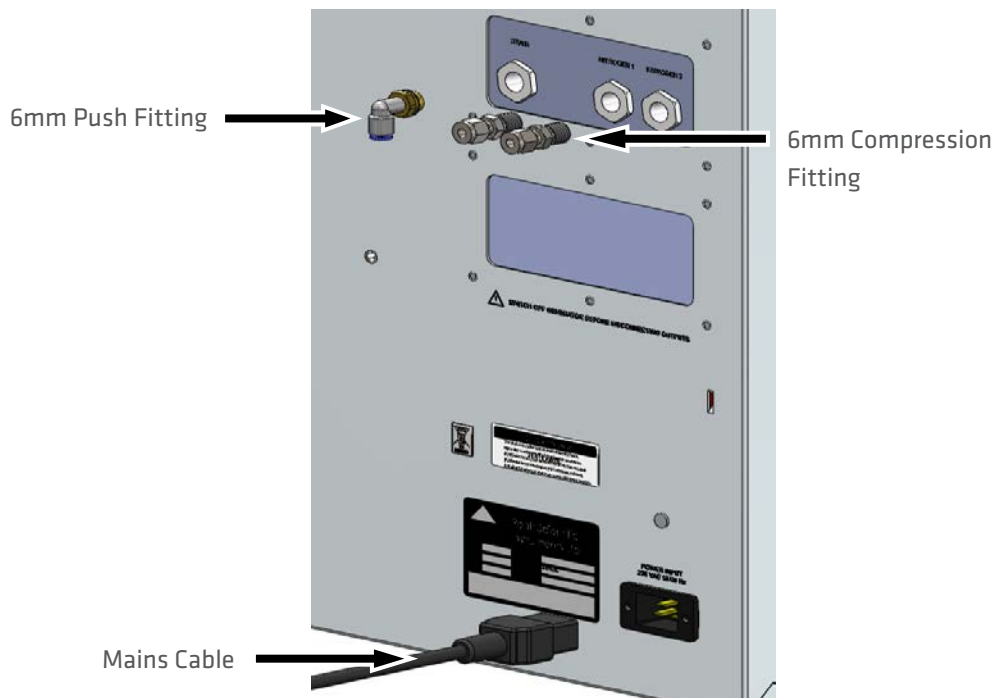

Figure 3: Rear Connections

Fittings Kit

Supplied in the Fittings Kit are all the fittings required to connect the Genius 3020 Generator to the application. The contents of the Fittings Kit are as follows:

- | | |
|--------------------------------------|------|
| 1. 8mm Hex Key | × 1 |
| 2. 6mm Push Fit Tube Fitting | × 1 |
| 3. ¼" Compression Tube Fitting | × 2 |
| 4. 6mm Silver Tubing | × 4m |
| 5. ¼" Teflon Tubing | × 6m |
| 6. 6mm Teflon Tubing | × 6m |
| 7. C19 Mains Cable (UK) | × 1 |
| 8. C19 Mains Cable (Euro) | × 1 |
| 9. C19 Mains Cable (US) | × 1 |
| 10. Silencer Fitting | × 2 |
| 11. Installation Guide - Genius 3020 | × 1 |
| 12. User Manual - Genius 3020 | × 1 |

All of the Generator output ports are located on the output panel at the rear of the Generator.

Drain Connection

Fit the 6mm push fit fitting (item 2 from fittings kit) to the drain port located on the output panel. Tighten using a 16mm or 5/8" spanner. Use the 6mm tubing (item 4 from fittings kit) to connect this to a suitable drain connection or container. It should be noted that the Generator can expel a considerable amount of water from this (dependant on ambient humidity).



If a container is used it should be emptied at regular intervals. The container must NOT have an air tight seal as water and air are expelled at pressure.

Electrical Connection

Connect the Generator to a 230 volt single-phase supply using the power cord provided. If the appropriate power cord is not supplied; a new plug, rated to at least 12 amps, can be fitted by a qualified electrician.



This unit is classified as SAFETY CLASS 1. THIS UNIT MUST BE EARTHED. Before connecting the unit to the mains supply, please check the information on the serial plate. The mains supply must be of the stated AC voltage and frequency.

EARTH/GROUND (E):-	Green & Yellow	or	Green
LIVE (L):-	Brown	or	Black
Neutral (N):-	Blue	or	White

Our electrical requirements are 230VAC nominal +/- 10%. This means that the Generator can accommodate transients between 207VAC and 253VAC. However, running continuously at voltages less than 220V is not recommended and extended periods at these extremes can have a detrimental effect on the operation and life of the Generator.

To ensure that the correct voltage is being supplied to the Generator, the Genius 3020 comes equipped with an inbuilt voltmeter. This is located on the underside of the compressor compartment, Figure 4 below, and will measure and display the mains voltage that is being supplied to the Generator.

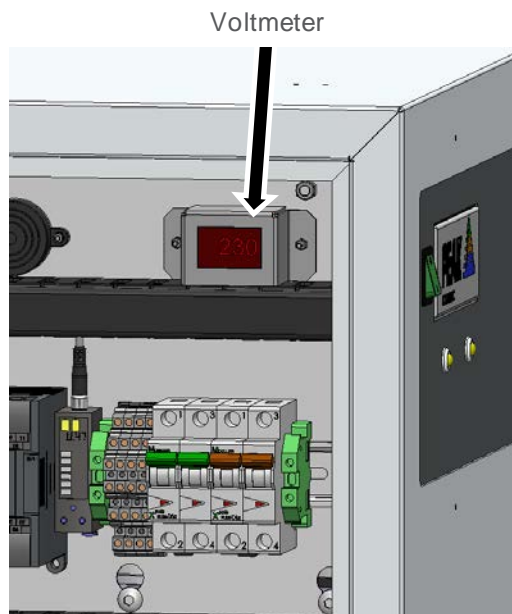

Figure 4: Voltmeter Location

The voltmeter should be checked prior to the initial purge of the system. To do this, with the doors remaining off and with the Generator still connected to the

230 volt single-phase supply, the unit should be powered ON using the power switch (identified by “I”).



Do not touch anything inside the Generator whilst the side panels are removed and the mains power is connected to the unit

When the Generator is switched on, the input voltage will be displayed on the voltmeter. If this reading is 219V or less, then we would highly recommend fitting a transformer. This can be ordered directly from Peak Scientific with the order number being as below.

Product Description	Part Number
Dual Tap Transformer 200V - 230V	06-3210

Table 1: Additional Transformer

On completing the voltage check, the Generator should be powered OFF using the switch on the front panel, the power cord removed from the rear of the generator and the door panels refitted.



Ensure the Earth wires are reconnected to the side covers when refitting.

Selector Switches

The Genius 3020 generator incorporates two completely separate systems delivering two separate outputs.

With the generator powered on, either system can be switched on or off when necessary, by using the selector switches on the front panel, see Figure 2. Either system can be turned on or off at any time.

Initial Purge Run



Before the Generator is connected to the application, the Generator should be operated in isolation (i.e. not connected to the application) for thirty minutes. This is to ensure any impurities present are purged from the system. Failure to do this may harm the application.

Before re-connecting the Generator to the mains and switching it on for the isolation run, it is necessary to fit the silencer (supplied in the fittings kit) to the outlet ports of the output panel as shown below.

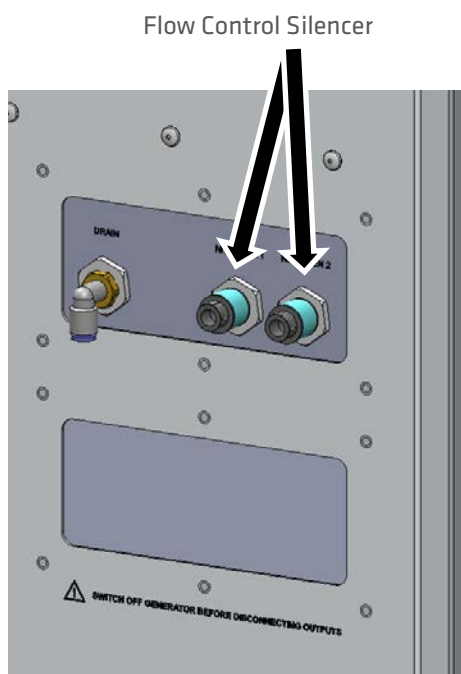

Figure 5: Fitting Silencer

For both systems to operate and complete the initial purge run, it is necessary to switch both of the system selector switches, shown in Figure 2, to the 'ON' position. Please note that both systems operate on the same platform with the same working components though completely separately from each other thus giving two completely separate sources of Nitrogen.

Once this is done, the Generator can be re-connected to the mains and switched on.

Pressure will start to build in both systems in their respective internal storage tanks which can be monitored by watching the output pressure gauge on the front panel. This will climb to the factory set pressures as noted in the [specifications](#).

Once this pressure is reached, the compressors in each system will continue to run until the internal tanks upper pressure limit for that system is reached and the compressors have run for a period of at least two and a half minutes.

The compressors will then rest until the internal tank lower pressure limits is reached. Once this limit is reached the compressors will switch back on again. This compressor cycling is normal and will continue throughout the operation of the Generator.

When the systems have been operated for a period of 30 minutes, all the internal pipe-work and storage tanks will have been purged with Nitrogen.

The Generator is now purged and the tubes can be connected at the rear of the unit.



Should a system be disconnected from its application, the 30 minute purge run must be performed on that system before re-connecting it to its specified application.

Connecting to the Application

Once the initial purge run of 30 minutes has completed the Generator is now ready to be connected to the application(s).



The pressure in the internal storage tanks must be allowed to dissipate before disconnecting the flow control silencer and connecting the Generator to the application(s)

Attach either the 6mm elbow or ¼” compression fittings to the outlets of the Generator. Using the 6mm or ¼” tubing supplied, connect the outlets of the Generator to the inlets on the application.

If you require more tubing than is supplied please refer to the [Tubing Lengths](#) section.



Once the tubing is connected to the application, please ensure that it is thoroughly checked for being leak-tight. Even the slightest leak in the gas supply between the Generator and the application can lead to a reduction in efficiency.

Tubing Lengths



The diameter of the tubing which will be connected to the gas outlet is important and is determined by the length of tubing required. Failure to follow these recommendations could lead to pressure between generator and application.

- | | |
|-------------------|---|
| < 10 meters: | Use 6/4 (6mm O/D, 4mm I/D) P.T.F.E. tubing. |
| > 10 - 40 meters: | Use 10/8 (10mm O/D, 8mm I/D). Tubing and fittings not supplied in the fittings kit. |
| > 40 metres: | Please contact Peak Scientific with the relevant distance and we will calculate the flow resistance and the tubing size required. |

A combination of 6/4 and 10/8 tubing may be used to ensure that there is no large diameter tubing within the lab (i.e. for the first 20 meters from the Generator use 10/8 and the final 10 meters to the application use 6/4 tubing). Keep the connections and bends to a minimum.

The imperial equivalents are: 6/4 = 1/4” O/D, 3/16” I/D.
10/8 = 3/8” O/D, 5/16” I/D.

IMPORTANT DOCUMENTS



Warranty Entitlement

To register your generator for your warranty entitlement, send the completed form to Peak Scientific by:

- **Email** warranty@peakscientific.com
- **Online** http://www.peakscientific.com/service-and-support/warranty_registration
- **Phone** +44 (0)141 530 4185
- **Fax** +44 (0)141 812 8200

PRODUCT WARRANTY REGISTRATION	
COMPANY:	CONTACT NAME:
ADDRESS:	
	EMAIL ADDRESS:
CITY/TOWN:	GENERATOR SERIAL NUMBER:
POSTCODE:	
COUNTRY:	MODEL TYPE:
TELEPHONE:	INSTALLATION DATE (DD/MM/YYYY):

Important Please Note:

You have 1 month to register your Peak Scientific product from the date of shipment.

If you wish to defer installation of your generator you must notify Peak Scientific within 1 month of the shipment date. This can be done by emailing warranty@peakscientific.com Once registered the warranty will be honoured for a period of 12 months after the installation date.

For any generators that remain unregistered the warranty will begin from date of shipment.

Thank you on behalf of Peak Scientific.

Normal Operation

The Genius 3020 Gas Generator is designed specifically to minimize operator involvement. Given that the system is installed as described in earlier sections and is serviced in accordance with the specified maintenance recommendations (see [Service Requirements](#)), then it should simply be a matter of turning the Generator on when it is required.

The Generator will automatically produce the factory set flow and pressure as detailed in the [Technical Specifications](#).

On Demand Gas

The Generators individual systems produce gas on demand. If the application is operating and requires a gas flow, the system it is connected to will supply this to suit the requirements of the application. If the application requirement for gas stops, the system will also stop, once it has reached its upper set limit in the internal storage tanks. If the demand from the application starts again, the system will detect the demand for gas and will automatically start again to suit the demand.

Generator Cycling

The Generator and its individual systems are designed for the internal compressors to cycle. This cycling reduces the duty (run time) on the compressors. The rate at which they cycle will be dependent on the gas required to satisfy the demand of the application. If the application demands the maximum gas flow of the system, the compressor duty on that system will be higher, (the rest period in the compressor cycle will be shorter). If the application demand is lower than the maximum gas flow, then the duty on the compressors will decrease, (the rest period in the compressor cycle will be longer). If the Generator is installed in an extreme environment or is subjected to low supply voltage or high altitude the compressors may undergo periods where they do not cycle (see [High Duty Indication](#)).

Unusual Operation

If at any time the Generator begins to emit excessive noise or vibration, then it should be switched off and you should contact Peak Scientific or the Peak Partner from which the Generator has been purchased.

Service Requirements

Service Schedule

Service Interval	Component	Part No.	Qty.
12 months	Coalescing filter element	00-4424	4
	Inlet filter element	02-1054	1
	RAC filter element	00-4425	2
5000 hours	Compressor assembly	08-8316	4
Alternative to compressor assembly **	Compressor re-fit kit	06-8320	4

Table 2: Service schedule

** Compressors can be re-fitted as an alternative to replacement up to a maximum of 3 times, this is a more cost effective solution, however a degree of technical expertise is required and can be time consuming. Please contact your service provider for more information.

As an alternative to purchasing the 12 month service items individually an Annual Service Kit is available as one part number. This contains all the filters required for this Generator and offers a costs saving over buying the components separately.

Purchase Interval	Component	Part No.	Qty.
12 months	Genius 3020 Annual Service Kit	08-4782	1

Table 3: Annual Service Kit

Service Indication

The Genius 3020 counts the accumulative run-time (in hours) for the internal compressors. The Generator has the following Service Indication Stages for each system:-

Stage 1

Once either system reaches a total of 5000 run hours the service LED indicator (yellow) on the front of the Generator will illuminate. The screen located on the PLC will indicate which system and compressor(s) are due a service.

This is to make the user aware that a service of the system is due and should be planned at the earliest convenience. The Generator will continue to operate as normal with the LED on.



It is highly recommended that the compressors are serviced or replaced after 5000 run hours to prevent any unplanned downtime. Please contact your service provider for more information

Stage 2

If the service is not completed the Generator will continue to run. Once the system reaches a total of 5250 run hours, the service LED indicator (yellow) will start to flash. The screen located on the PLC will indicate which system and compressor are due a service.

This is to make the user aware that the service of the Generator is now overdue and must be completed immediately to ensure the continuous trouble free operation of the Generator.



Once 5250 hours is reached it is highly likely that the compressors will fail in the near future. Please contact your service provider as soon as possible to arrange a service or replacement of your compressors.

Service Indication Reset

Once the service has been completed the Service Indication LED can be reset in the main control PLC. This will be performed by the Peak Service Engineer or trained service representative that completes the service operation.

Service Plans

Peak Scientific offer two service plans. The Complete Service Plan, specifically designed for Generators operated in critical environments, also includes full breakdown cover, guaranteed response times and Generator upgrades if available. Our Standard Service Plan, covering the basic needs of our Generators, features special deals on spare parts and breakdowns.

If you want to know more about our Service Plan options and how we ensure that your instrument can run with the maximum uptime and performance, please contact us at maintenance@peakscientific.com

Cleaning

Clean the outside of the Generator only using warm soapy water and a clean damp cloth. Ensure the cloth is thoroughly rung out to remove excess fluid prior to use.



Cleaning should only be undertaken with the power switched off and the power cord removed from the rear of the Generator.



Under no circumstances should any solvents or abrasive cleaning solutions be used as these can contain fumes that could be harmful to the Generator.

High Duty Indication

The Genius 3020 has a 'HIGH DUTY' indicator on the front panel. This indicator monitors the running condition of the internal compressors of both systems and illuminates when they have been operating continually for a period of 8 hours.

There are a number of extreme conditions that can affect the duty cycling of the compressors inside the Genius 3020. These extremes include very high ambient temperatures, low supply voltages, a very high flow requirement and locations of high altitude. Any one of these or a combination of a number of these extremes can be evident in a customer site.

While the Genius 3020 Generator is designed to operate fully in these conditions it should be noted that the effect of these extremes can force the compressors to run continuously. The compressors are fully capable of running continuously with no detrimental effect. However it should be noted that if this is the case it will increase their duty and they will reach the 5000 hour recommended service interval quicker.

High Duty Indication Reset

If the compressors in either system have been operating continuously for a period of 8 hours the indicator light will be illuminated. Once the compressor(s) return to a cycling mode the indicator light will automatically switch off. There is no manual intervention required.

Indication of Fault



In most installations the 'HIGH DUTY' indicator will never be illuminated. If your Genius 3020 Generator has been operating for a significant period of time, then suddenly develops a 'HIGH DUTY' indication with no apparent change in environmental conditions or flow requirements, it may be indicative of a problem with the system such as an external leak or imminent compressor failure.

If this is the case you should contact Peak Scientific or your service provider.



It should be noted that the Generator will continue to operate so long as it can maintain pressure during this indication.

Trouble Shooting

Problem	Possible Solution
The Generator will not switch on and the power switch does not illuminate.	<ul style="list-style-type: none"> • Ensure power cord is plugged into the Generator and that the power socket is turned on. • Check the fuse in the power cord plug. • Contact your service provider. 
The Generator will not switch on but the power switch is illuminated.	<ul style="list-style-type: none"> • Disconnect power cord from the rear of the Generator. Open the left hand panel and check that both circuit breakers are turned on (switch in the up position). Reconnect power cord. • Contact your service provider. 
Compressors are running but pressure is not building.	<ul style="list-style-type: none"> • Contact your service provider.
The mass spec is reporting low pressure.	<ul style="list-style-type: none"> • Check pressure gauges are showing normal pressure. • Contact your service provider.
Yellow "SERVICE" LED on front panel is on constantly.	<ul style="list-style-type: none"> • A compressor(s) due for service. Contact your service provider. • Refer to Service Indication section of this manual for further information.
Yellow "SERVICE" LED on front panel is flashing.	<ul style="list-style-type: none"> • A compressor(s) is overdue for service. Contact your service provider urgently. • Refer to Service Indication section of this manual for further information.
Yellow "HIGH DUTY" LED on front panel is on constantly.	<ul style="list-style-type: none"> • A compressor(s) has not cycled for a period of 8 hours. Refer to the High Duty Indication section of this manual. • Ensure ambient temperatures are within the specification. • Ensure there are no leaks between the Generator and the mass spec.

Peak Scientific UK

Fountain Crescent
Inchinnan Business Park
Inchinnan
PA4 9RE
Scotland, UK

Tel: +44 (0)141 812 8100
Fax: +44 (0)141 812 8200

Peak Scientific Germany

Herriotstrasse 1
60528 Frankfurt

Germany

Tel: +49 (0)69 677 33 490
Fax: +49 (0)69 677 33 200

Peak Scientific Taiwan

4F.-6, No.736
Zhongzheng Rd.
Zhonghe Dist.
New Taipei City

Tel: +886 2 8226 2383
Fax: +886 2 8226 9499

Peak Scientific North America

19 Sterling Road
Suite #1
Billerica, MA 01862

USA

Tel: +1 866 647 1649
Fax: +1 978 608 9503

Peak Scientific China

Room 606 Building 1
Lane 2277 Zuchongzhi Road
Pudong New Area
Shanghai
201203, China

Tel: +86 21 5079 1190
Fax: +86 21 5079 1191

Peak Scientific Brazil

Peak Scientific Brasil
Av. Quieroz Filho
1700 - torre Sunny-Conj. 602
São Paulo SP Brasil

Tel: +1 866 647 1649

Peak Scientific India

202, Amsri Shamira
Old Lancer Line
Opp. St. Mary's Degree College
S.D. Road Secunderabad
500 025, India

Tel: +91 40 2780 0663
Fax: +91 40 2780 0663

Peak Scientific Mexico

Solon 352
Col. Los Morales Polanco
11530 Mexico, D.F.

Mexico

Tel: +1 866 647 1649
Fax: +1 978 608 9503

Peak Scientific Japan K.K.

2-7-56, 2F Fuji Building 28
Kita Aoyama, Minato-Ku
Tokyo, Japan
107-0061

Tel: +81 3-6864-0468

Peak Scientific Africa

PO Box 478
Somerset Mall
7137

South Africa

Tel: +27 (0)2185 16542
Fax: +27 (0)8654 64473

Peak Scientific Australia

PO Box 65
Belmont
Victoria 3216

Australia

Tel: +61 1300 965 352

Peak Scientific Singapore

3 Science Park Drive
#03-14 The Franklin
Science Park Drive 1
Singapore, 118223

Tel: +65-6777 1966
Fax: +65-6777 1978